

# Konštrukčné detaily

## Zatepľovací systém s polystyrénom – minerálnou vlnou

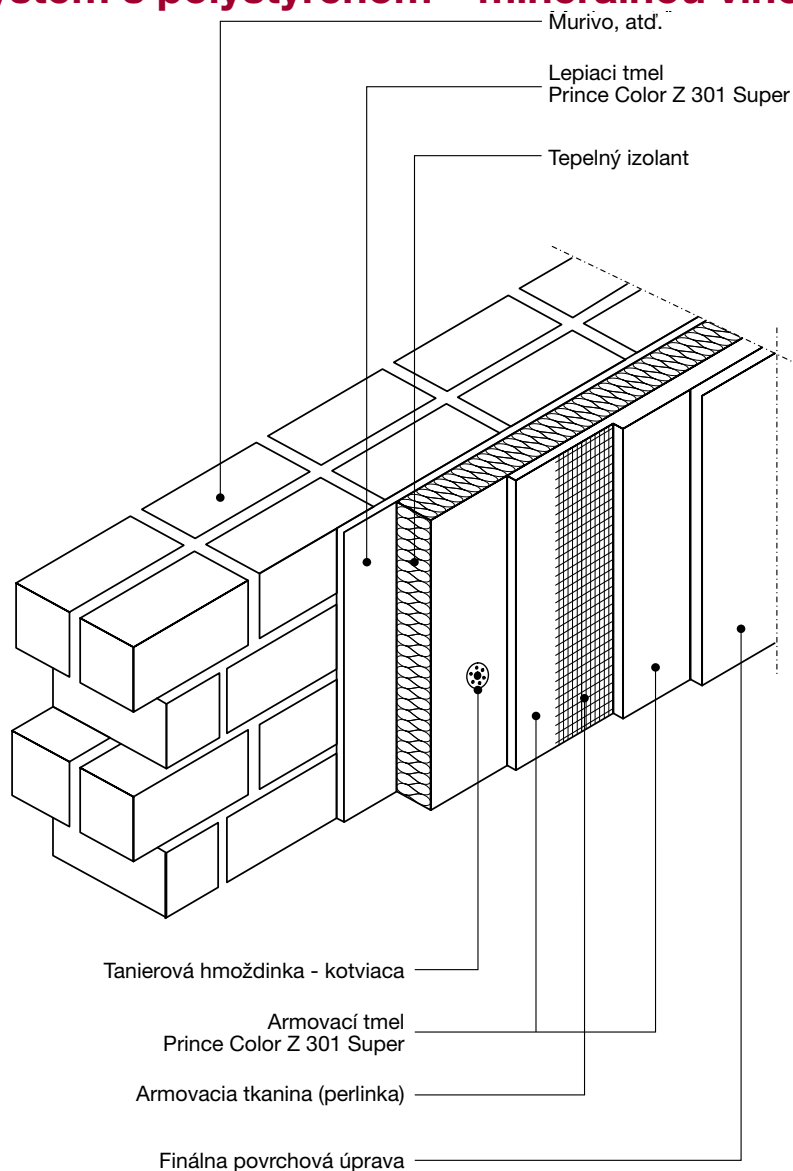

## Armovanie rohov objektu

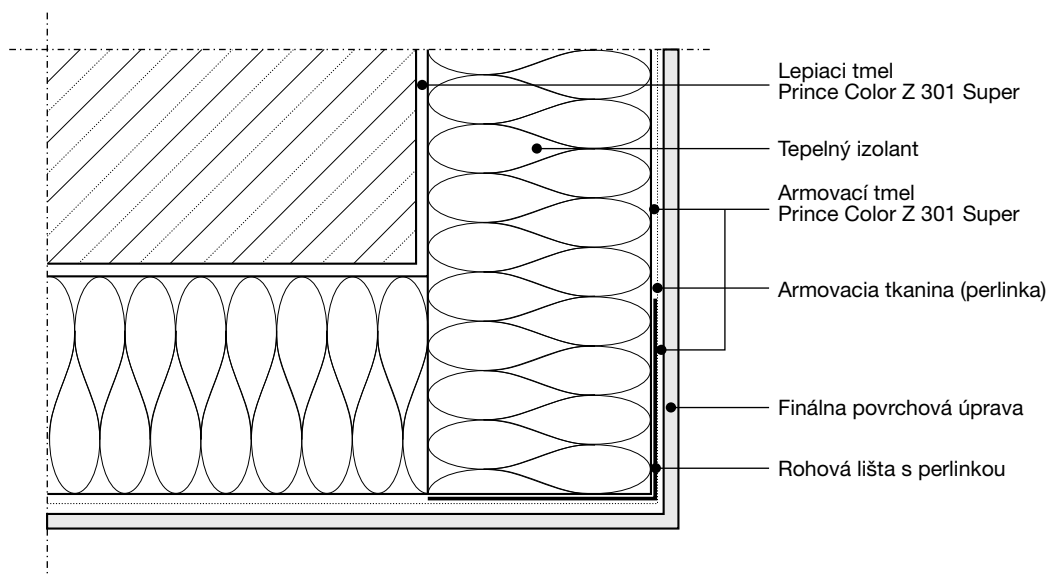

## Diagonálne výstuhy okien (dverí)

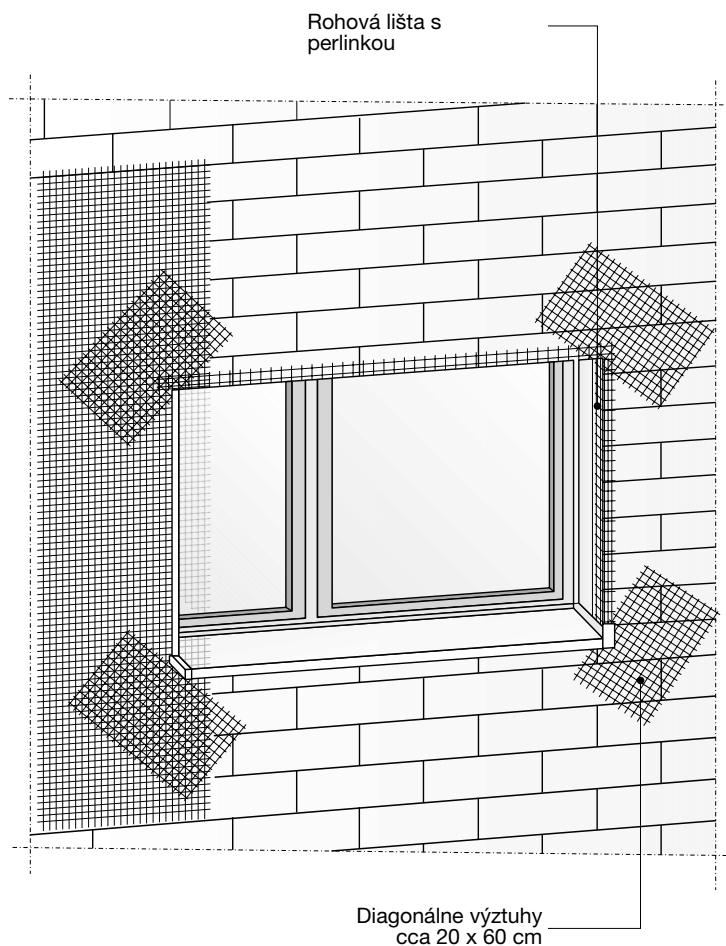

## Ukončenie zateplenia soklovou omietkou – nezateplený suterén

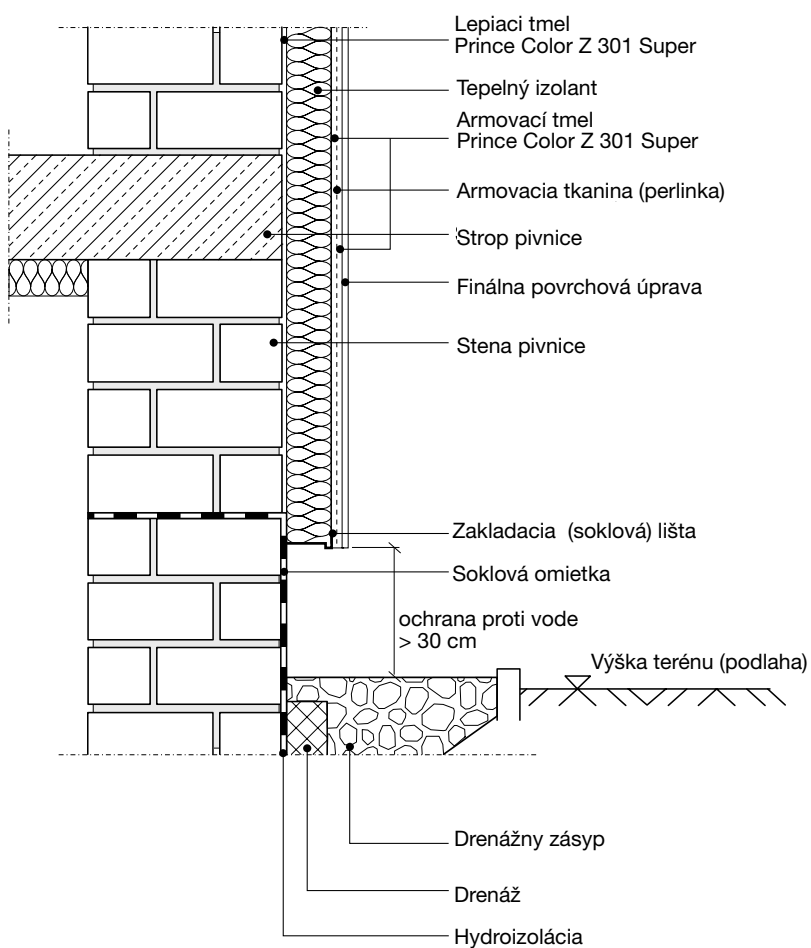

## Ukončenie zateplenia balkónov a terás I.

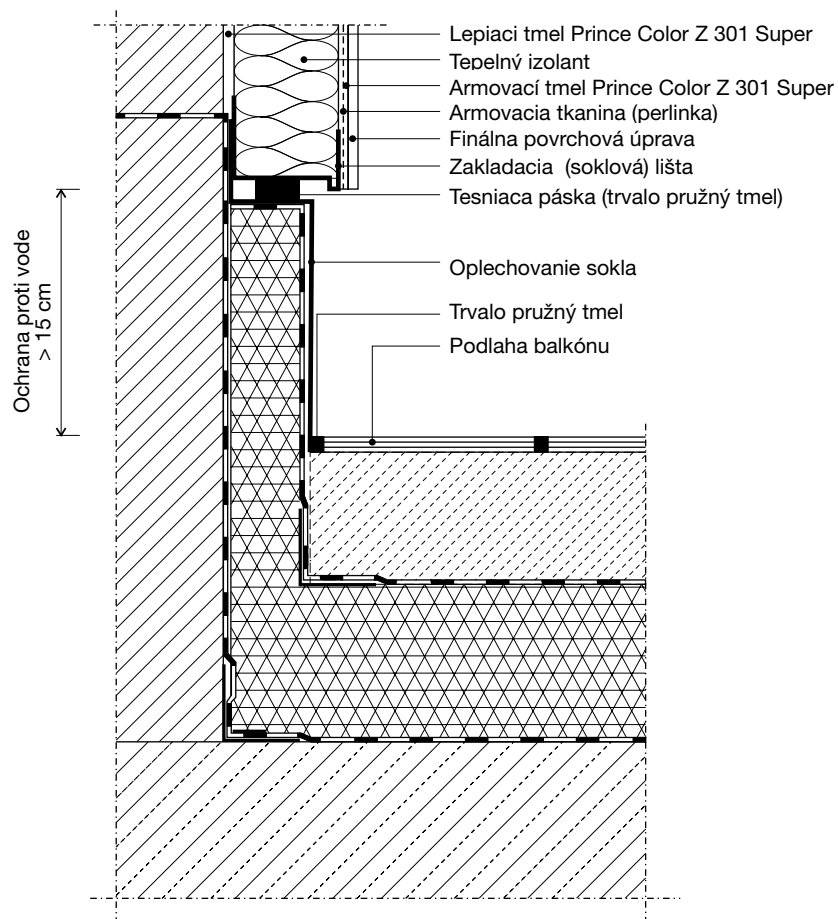

## Ukončenie zateplenia balkónov a terás II.

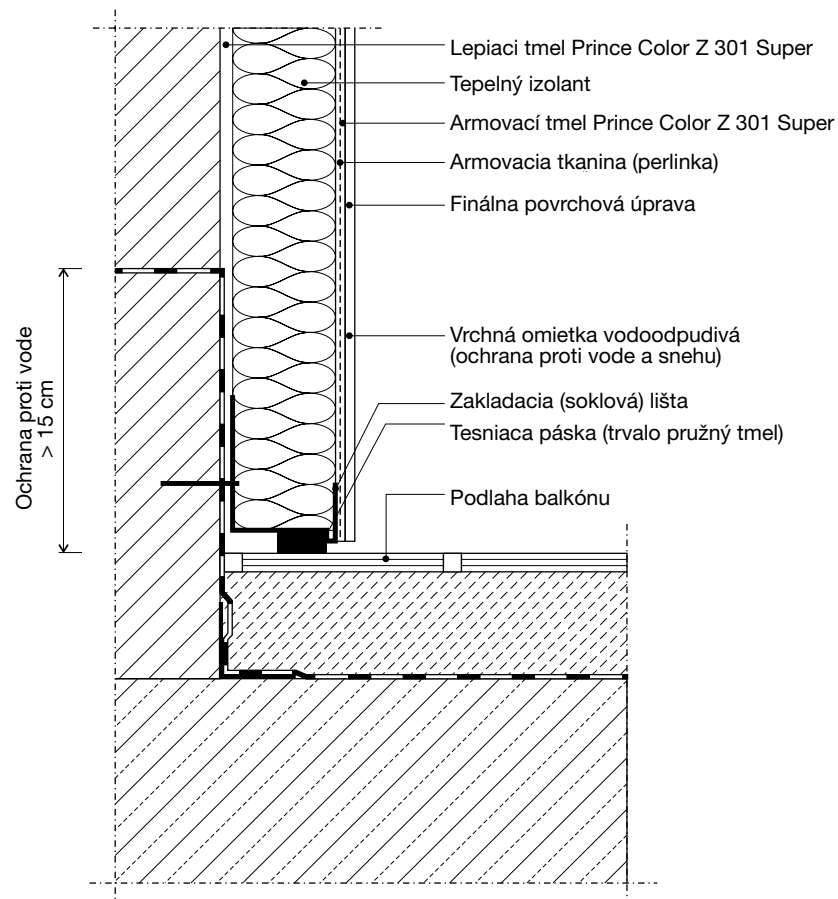

## Dilatačné profily

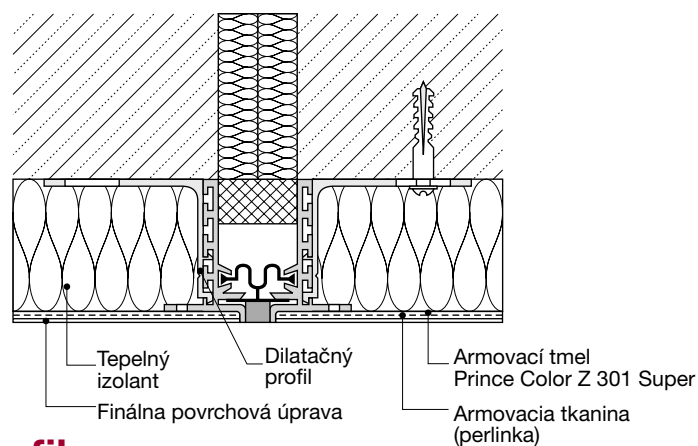
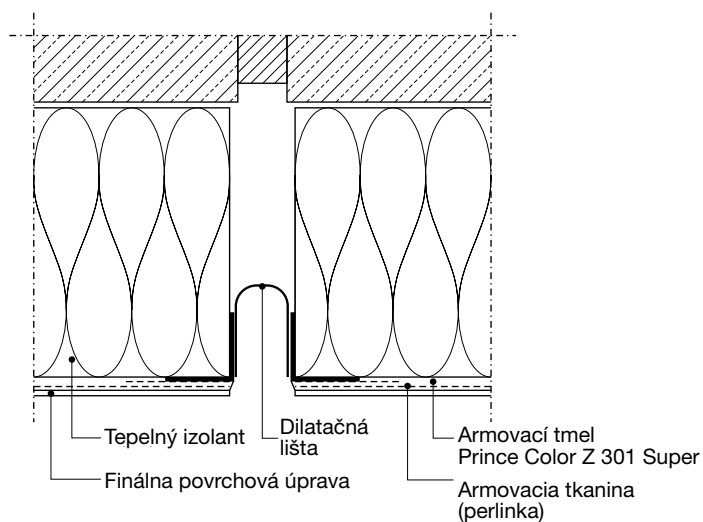

## Rohové dilatačné profily

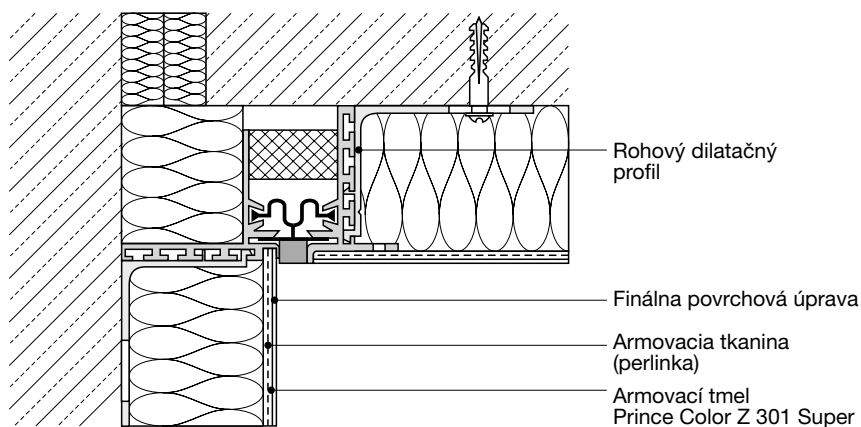
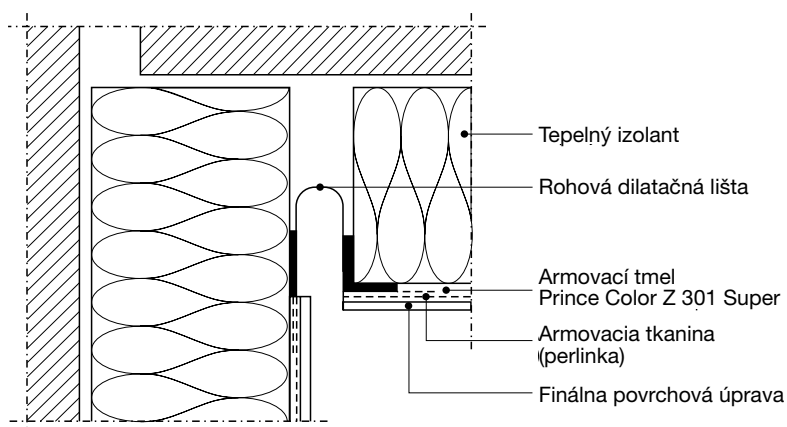

# Ukončenie zatepľovacieho systému pri okennom ráme

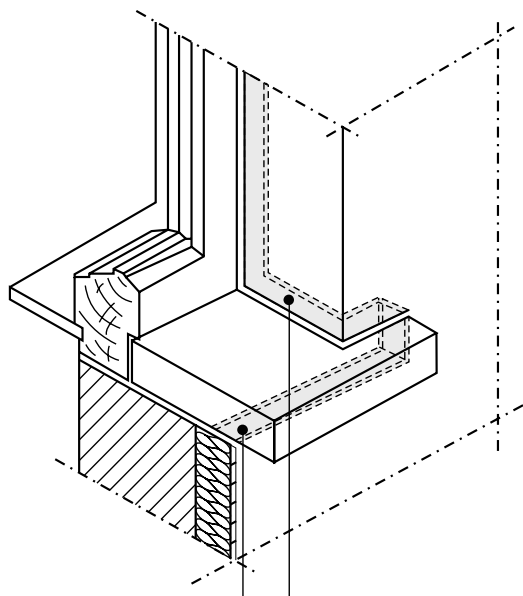

Tesniaca páska (trvalo pružný tmel)

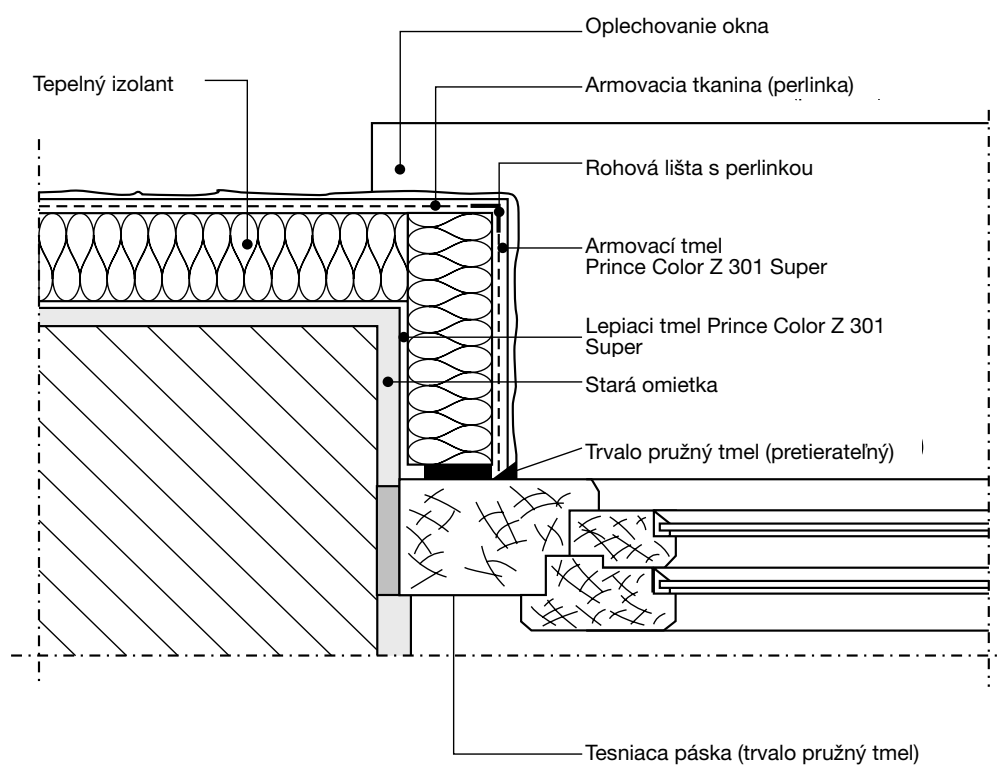

## Ukončenie zatepľovacieho systému pri okne bez ostenia – horizontálny rez

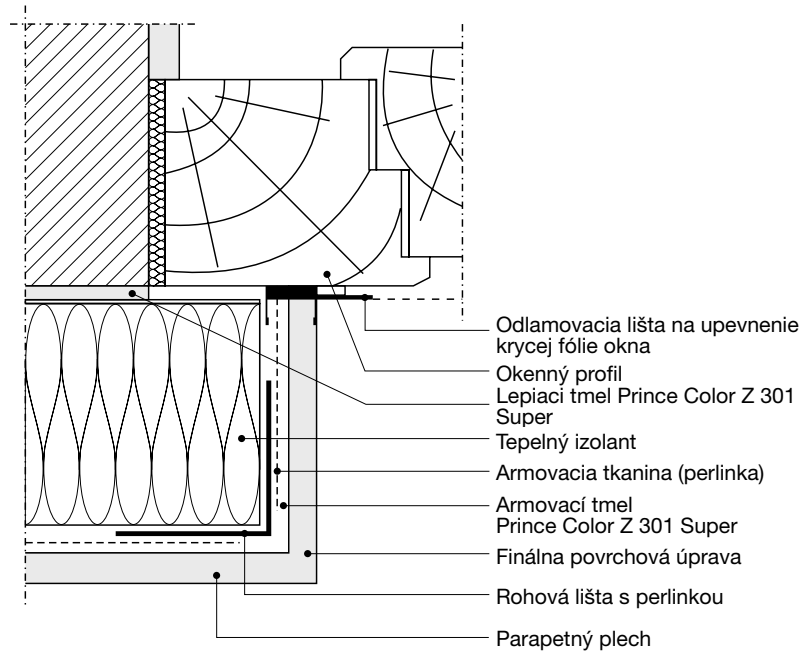

## Ukončenie zatepľovacieho systému pri okne bez ostenia – vertikálny rez

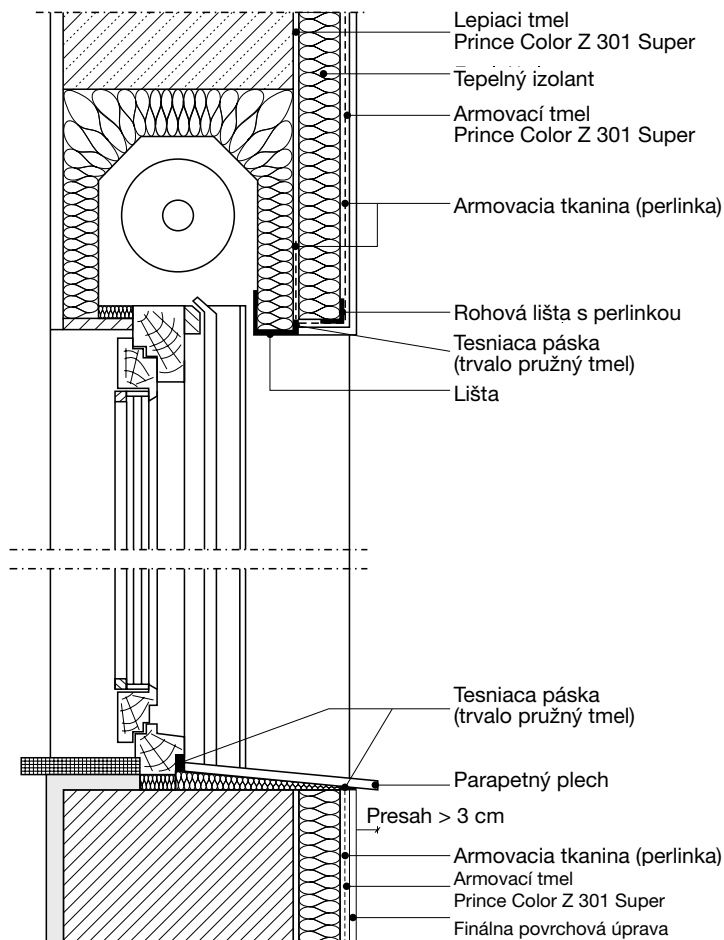

## Ukončenie zatepľovacieho systému pri okne s ostentím – horizontálny rez

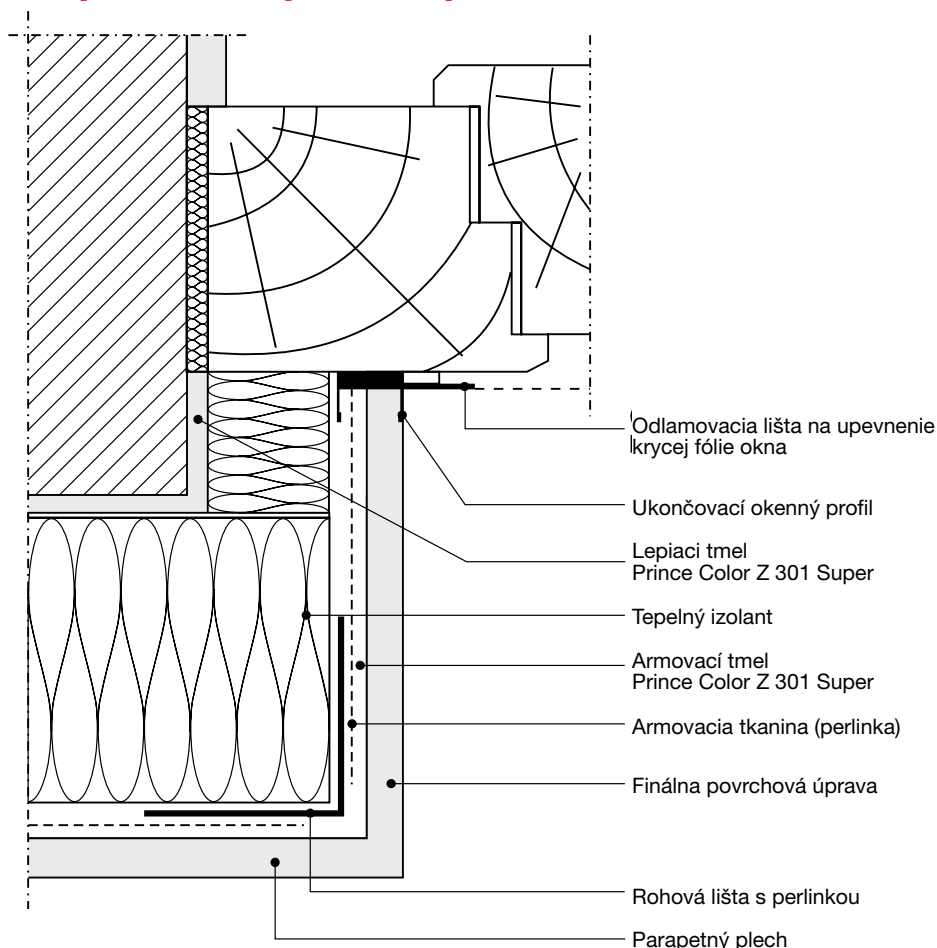

## Ukončenie zatepľovacieho systému pri okne s ostentím – vertikálny rez

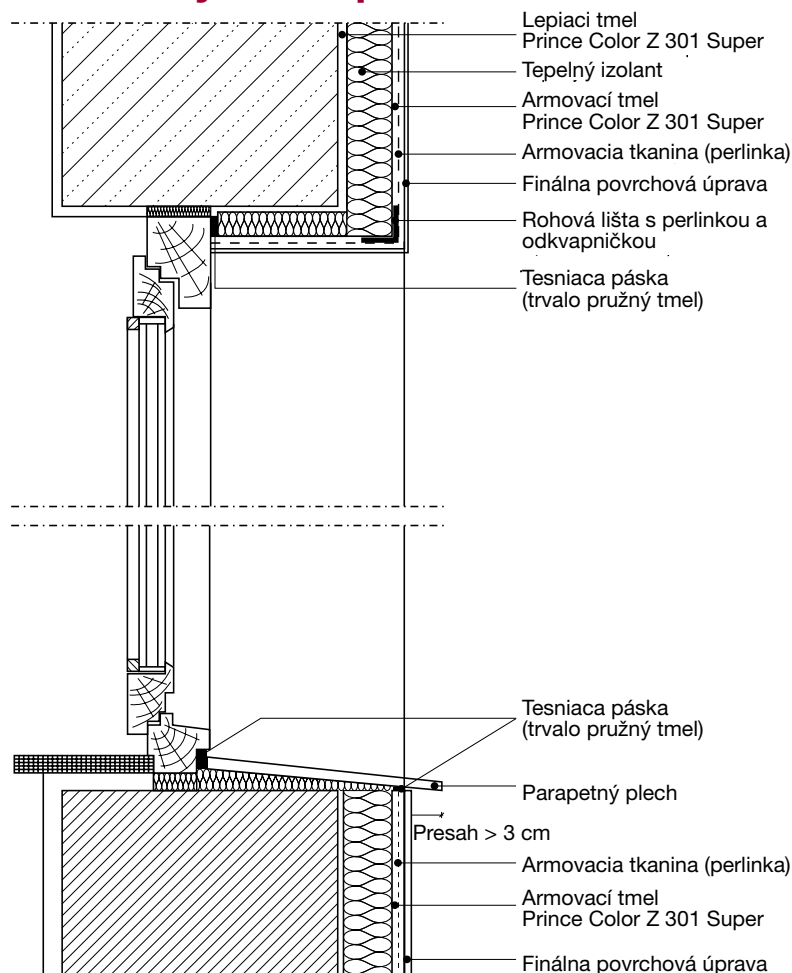

## Bočné ukončenie zateplovacieho systému pri streche

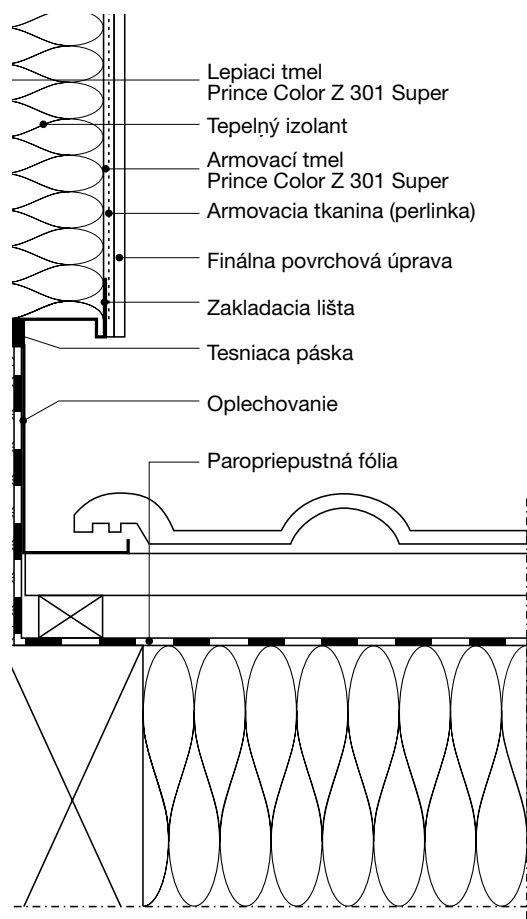

## Ukončenie zateplovacieho systému pri plochej streche s atikou

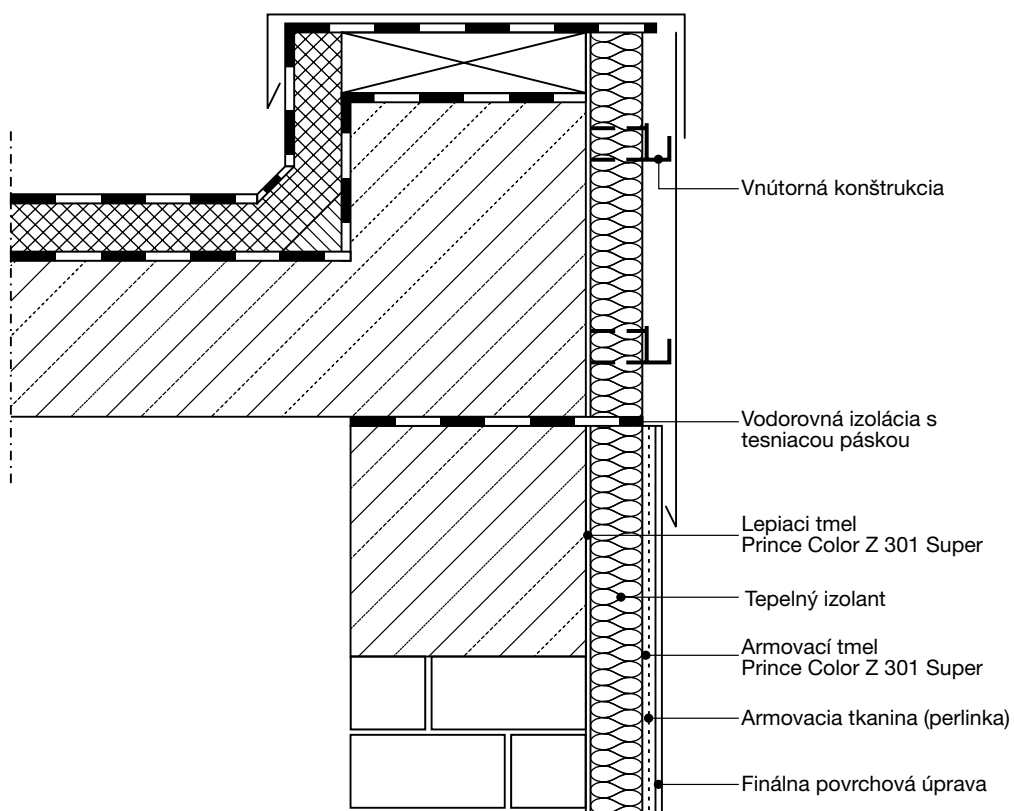

## Ukončenie zatepľovacieho systému pri šikmej odvetranej streche

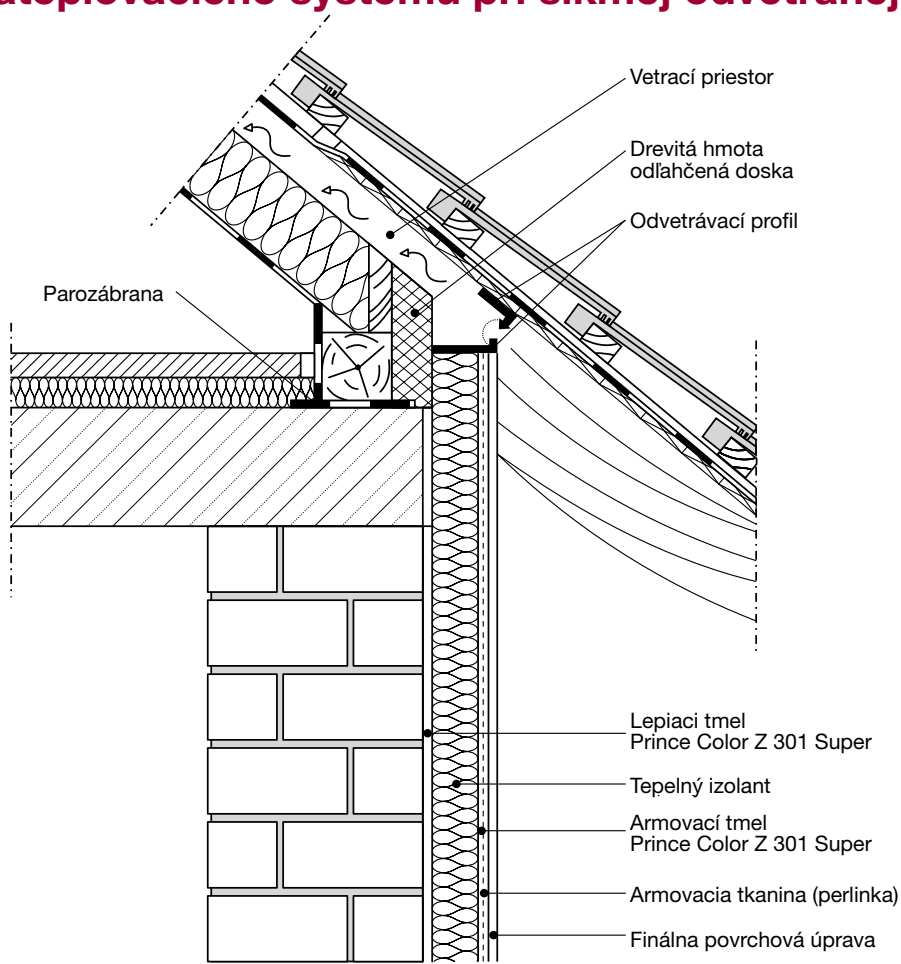

## Ukončenie zatepľovacieho systému pri podbitej streche

